

SECTION VIEW

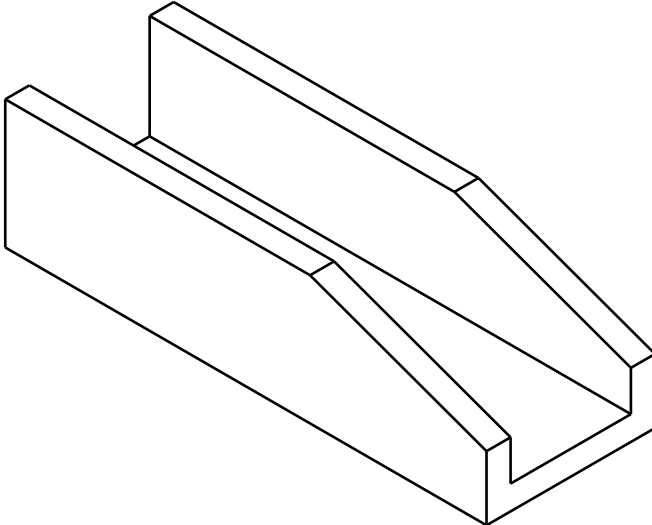
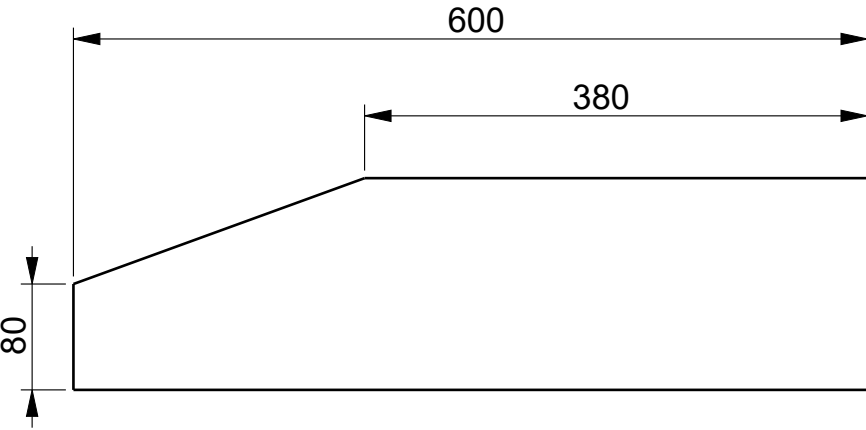
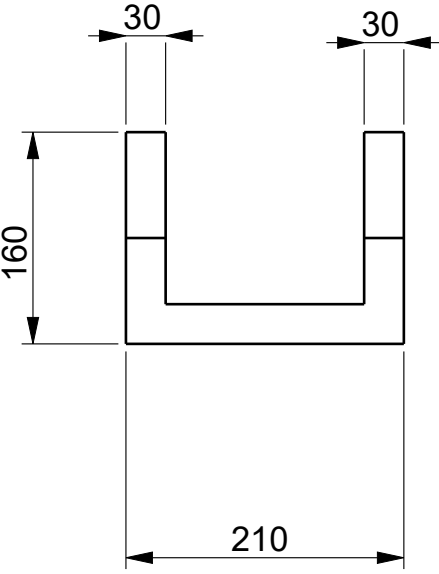

MODEL NAME	C073
DESCRIPTION	WATER CHANNEL